

# Rotary knob switches

Serie 419

Type 419

Basic design: width 19.4 mm, plastic moduled spindle diameter 6 mm

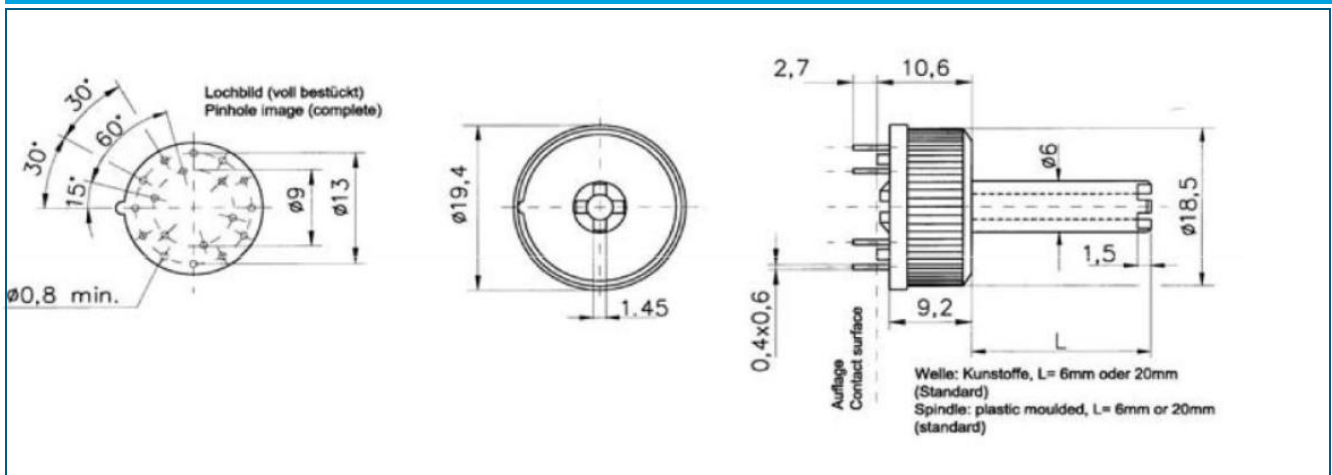
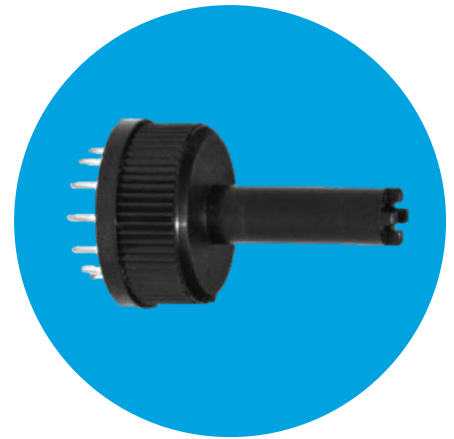

## Technical data

Switch resistance initial value	≤ 25 mΩ	Switching mode	Non shorting (white bottom plate), shorting (black bottom plate)
Switch resistance after 15 000 cycles	≤ 50 mΩ	Number of wafers	1 / single wafer
Insulation resistance	1 x 10 <sup>9</sup> Ω	Indexing angle	30°
Test voltage	1 kV- / 1 kV DC	Stops	Fixed or without stop
Switching voltage	Max. 150 V DC / AC	Operating torque	2 - 4.5 Ncm
Switching current	Max. 130 mA, Ag plated	Solder terminals	For printed circuit
Switching power	Max. 5 VA, Ag plated	Contact material	Silver plated copper alloy
Steady current at 20 °C ambient temperature	3 A	Insulation material	Plastic
Operating life at maximum power	≥ 15 000 cycles	Spindle	Plastic, L = 6 or 20 mm (Standard)
Operating life no load	≥ 20 000 cycles	Switching combinations (see page 2)	1 x 2 to 1 x 12; 2 x 2 to 2 x 6; 3 x 2 to 3 x 4; 4 x 2 to 4 x 3; 6 x 2
Capacity between two contacts	≤ 3 p F		

# Rotary knob switches

Serie 419

Type 419

Basic design: width 19.4 mm, plastic moduled spindle diameter 6 mm

## Switching Combinations

1-polig  
1 Pole

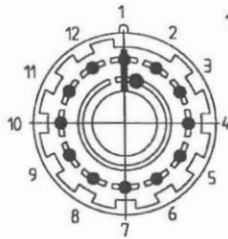

1 x 2 - 1 x 12

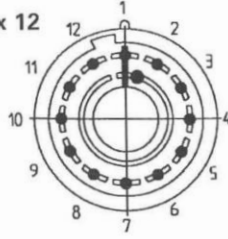

1-polig  
durchdrehbar  
1 Pole  
without stop

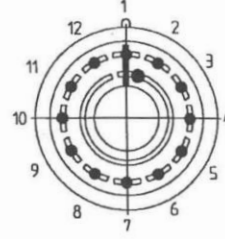

2-polig  
2 Pole

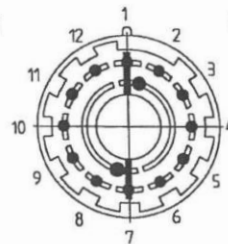

2 x 2 - 2 x 6

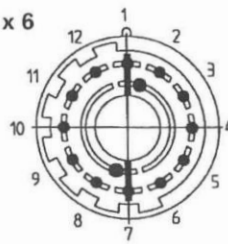

2-polig  
durchdrehbar  
2 Pole  
without stop

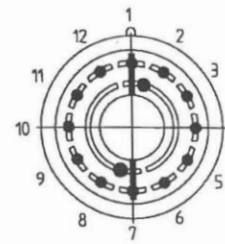

3-polig  
3 Pole

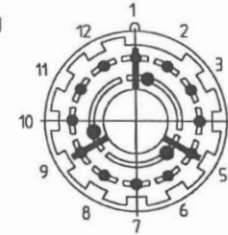

3 x 2 - 3 x 4

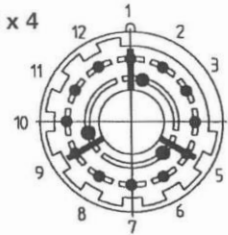

3-polig  
durchdrehbar  
3 Pole  
without stop

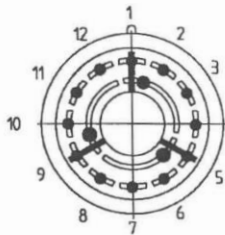

4-polig  
4 Pole

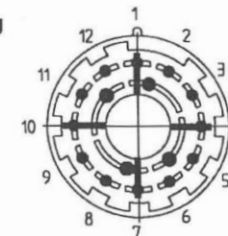

4 x 2 - 4 x 3

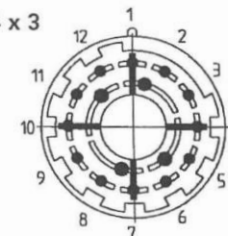

4-polig  
durchdrehbar  
4 Pole  
without stop

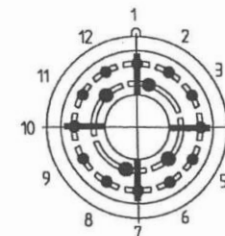

6-polig  
6 Pole

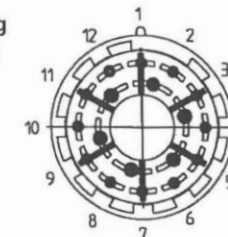

6 x 2



6-polig  
durchdrehbar  
6 Pole  
without stop

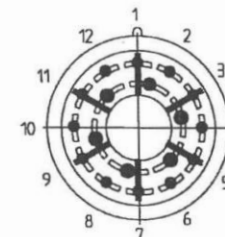

Erläuterung:  $2 \times 3 \cong 2$ -polig, 3 Schaltstellungen

Explanation:  $2 \times 3 \cong 2$  Pole, 3 Ways